

Datenblatt RB8

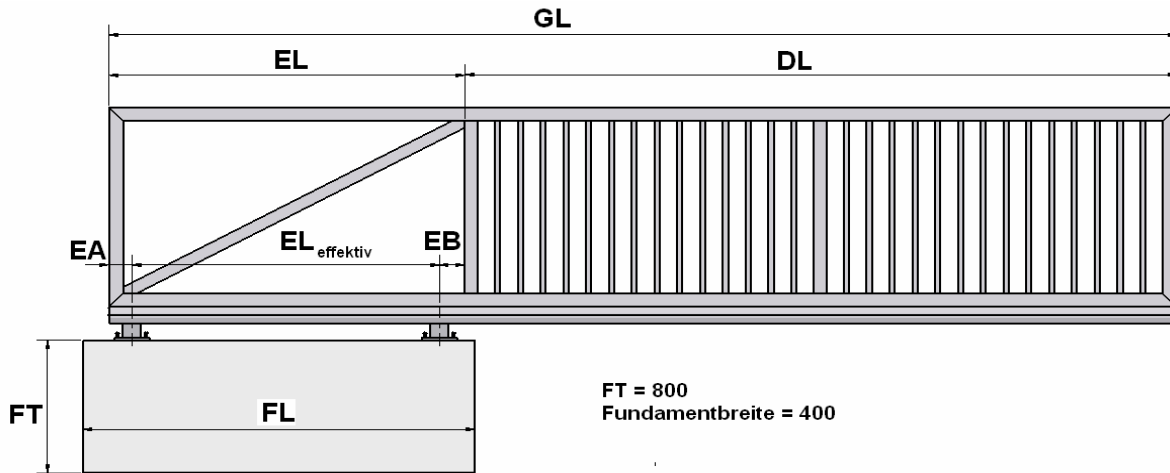

GL	DL	EL	EA	EB	EL _{effektiv}	zul. Masse	zul. Metermasse	FL
[mm]	[mm]	[mm]	[mm]	[mm]	[mm]	[kg]	[kg/m]	[mm]
5600	4000	1600	225	225	1150	328	59	1800
6300	4500	1800	225	225	1350	340	54	2000
7000	5000	2000	225	225	1550	349	50	2200
7700	5500	2200	225	225	1750	356	46	2400
8400	6000	2400	225	225	1950	362	43	2600
9100	6500	2600	225	225	2150	367	40	2800
9800	7000	2800	225	225	2350	371	38	3000
10500	7500	3000	225	225	2550	375	36	3200
11200	8000	3200	225	225	2750	378	34	3400
11900	8500	3400	225	225	2950	381	32	3600
12600	9000	3600	225	225	3150	383	30	3800

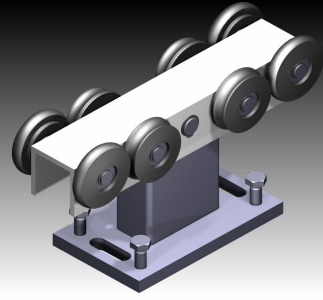